



## ***LCD COLOR TELEVISION***

***LT2618***

***LT3218***

***LT3718***

***LT4018***

## ***OPERATION MANUAL***

***Please read this manual carefully before operation.***

# CONTENTS

<b>IMPORTANT SAFETY INSTRUCTIONS</b> .....	1
<b>USING THE REMOTE CONTROL</b> .....	3
<b>BATTERIES FOR REMOTE CONTROL</b> .....	3
<b>PACKING LIST</b> .....	4
<b>GENERAL INTRODUCTION</b> .....	4
<b>BRIEF INTRODUCTION</b> .....	6
<b>REMOTE CONTROL</b> .....	9
Overview of the Remote Control .....	9
TV Functions .....	10
<b>INSTALLATION</b> .....	11
<b>GENERAL OPERATION</b> .....	11
<b>MENU OPERATION</b> .....	12
<b>FUNCTION INTRODUCTION</b> .....	12
Using the Channel Setting Menu .....	12
Using the Picture Setting Menu .....	13
Using the Audio Setting Menu .....	14
Using the General Setting Menu .....	15
Using the Timer Setting Menu .....	15
Using the Child Lock Setting Menu .....	16
Using the PC Setting Menu .....	17
<b>OTHER FUNCTIONS INTRODUCTION</b> .....	17
Standby Mode .....	17
Signal Switch .....	17
Channel Selection .....	17
Volume Control .....	18
Mute .....	18
Sound Mode Selection .....	18
Picture Mode Selection .....	18
Information Display .....	18
Sleep Function .....	18
Recall .....	19
Zoom Mode .....	19
Still .....	19
PIP/POP/PBP Function .....	19
<b>TROUBLESHOOTING</b> .....	20
<b>SPECIFICATIONS</b> .....	21

**Note:**

The OSD and illustration in this manual may be somewhat different from the actual situation.  
Please take the LCD TV for standard.

## Important Safety Instructions

Electrical energy can perform many useful functions, but it can also cause personal injuries and property damage if improperly handled. This product has been engineered and manufactured with the highest priority on safety. But IMPROPER USE CAN RESULT IN POTENTIAL ELECTRICAL SHOCK OR FIRE HAZARD. In order to prevent potential danger, please observe the following instructions when installing, operating and cleaning the product. To ensure your safety and prolong the service life of your LCD TV product, please read the following precautions carefully before using the product.

1. **Read these instructions**---All operating instructions must be read and understood before the product is operated.
2. **Keep these instructions**---These safety and operating instructions must be kept in a safe place for future reference.
3. **Heed all warnings**--- All warnings on the product and in the instructions must be observed closely.
4. **Follow all instructions**---All operating instructions must be followed.
5. **Attachments**---Only use attachments/accessories specified by the manufacturer. Do not use attachments not recommended by the manufacturer. Use of improper attachments can result in accidents.
6. **Power source**---This product is intended to be supplied by a listed power supply indicated on the marking label. If you are not sure of the type of power supply to your home, consult your product dealer or local power company. For added protection for this product during a lightning storm, or when it is left unattended and unused for long periods of time, unplug it from the wall outlet and disconnect the cable system.
7. **Power cord protection** ---Protect the power cord from being walked on or pinched particularly at plugs, convenience receptacles, and the point where they exit from the apparatus.
8. **Overloading**---Do not overload wall outlets, extension cords, or convenience receptacles on other equipment as this can result in a risk of fire or electric shock.
9. **Entering of objects and liquids**---Never insert an object into the product through vents or openings. High voltage flows in the product, and inserting an object can cause electric shock and/or short internal parts. For the same reason, do not spill water or liquid on the product.
10. **Servicing**---Refer all servicing to qualified service personnel. Servicing is required when the apparatus has been damaged in any way, such as power-supply cord or plug is damaged, liquid has been spilled or objects have fallen into the apparatus, the apparatus has been exposed to rain or moisture, does not operate normally, or has been dropped.
  - a. When the power cord or plug is damaged.
  - b. When a liquid is spilled on the product or when objects have fallen into the product.
  - c. When the product has been exposed to rain or water.
  - d. When the product does not operate properly as described in the operating instructions.  
Do not touch the controls other than those described in the operating instructions. Improper adjustment of controls not described in the instructions can cause damage, which often requires extensive adjustment work by a qualified technician.
  - e. If the product has been dropped or the cabinet has been damaged in any way.
  - f. When the product displays an abnormal condition or exhibits a distinct change in performance. Any
11. **Damage requiring service**---If any of the following conditions occurs, unplug the power cord from the AC outlet, and request a qualified service person to perform repairs.
  - a. When the power cord or plug is damaged.
  - b. When a liquid is spilled on the product or when objects have fallen into the product.
  - c. When the product has been exposed to rain or water.
  - d. When the product does not operate properly as described in the operating instructions.  
Do not touch the controls other than those described in the operating instructions. Improper adjustment of controls not described in the instructions can cause damage, which often requires extensive adjustment work by a qualified technician.
  - e. If the product has been dropped or the cabinet has been damaged in any way.
  - f. When the product displays an abnormal condition or exhibits a distinct change in performance. Any

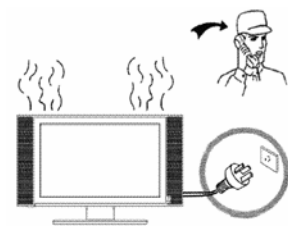

noticeable abnormality in the product indicates that the product needs servicing.

- 12. **Replacement parts**---In case the product needs replacement parts, make sure that the service person uses replacement parts specified by the manufacturer, or those with the same characteristics and performance as the original parts. Use of unauthorized parts can result in fire, electric shock and/or other danger.
- 13. **Safety checks**---Upon completion of service or repair work, request the service technician to perform safety checks to ensure that the product is in proper operating condition.
- 14. **Wall mounting**---Be sure to install the product according to the method recommended by the manufacturer. This is a safety feature.

15. **Stand**---Use only with the cart, stand, tripod, bracket, or table specified by the manufacturer, or sold with the apparatus. Do not place the product on an unstable trolley, stand, tripod or table. Placing the product on an unstable base can cause the product to fall, resulting in serious personal injuries as well as damage to the product. When mounting the product on a wall, be sure to follow the manufacturer’ s instructions. Use only the mounting hardware recommended by the manufacturer.

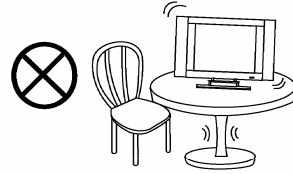

16. **Careful move**---When a cart is used, use caution when moving the cart/apparatus combination to avoid injury from tip-over. Sudden stops, excessive force and uneven floor surfaces can cause the product to fall from the trolley.



17. **Lightning**---Unplug this apparatus during lightning storms or when unused for long periods of time. For added protection for this television equipment during a lightning storm, or when it is left unattended and unused for long periods of time, unplug it from the wall outlet and disconnect the antenna. This will prevent damage to the equipment due to lightning and power-line surges.

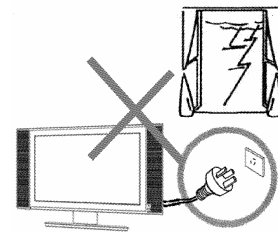

18. **Do not use this apparatus near water**---for example, near a bathtub, washbowl, kitchen sink, or laundry tub, in a wet basement, or near a swimming pool, and the like. Do not use immediately after moving from a low temperature to high temperature environment, as this causes condensation, which may result in fire, electric shock, or other hazards.

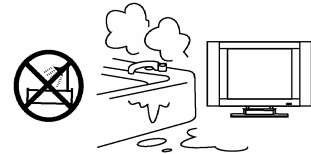

19. **Clean only with dry cloth**---Unplug this product from the wall outlet before cleaning. Do not use liquid cleaners or aerosol cleaners. Use a damp cloth for cleaning.



20. **Ventilation**---Do not block any ventilation openings. Install in accordance with the manufacturer instructions. The vents and other openings in the cabinet are designed for ventilation. Do not cover or block these vents and openings since insufficient ventilation can cause overheating and/or shorten the life of the product. Do not place the product on a bed, sofa, rug or other similar surface, since they can block ventilation openings. This product is not designed for built-in installation; do not place the product in an enclosed place such as a bookcase or rack, unless proper ventilation is provided or the manufacturer’ s instructions are followed.

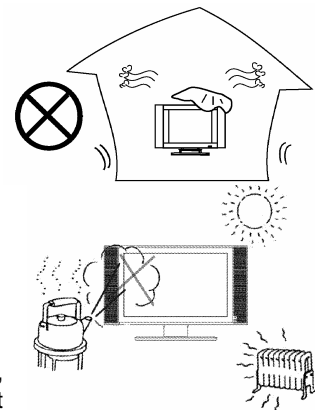

21. **Heat sources**---Do not install near any heat sources such as radiators, heat registers, stoves, or other apparatus (including amplifiers) that

produce heat.

**22. Panel protection**---The LCD panel used in this product is made of glass.

Therefore, it can break when the product is dropped or impacted upon by other objects. Be careful not to be injured by broken glass pieces in case the LCD panel breaks.

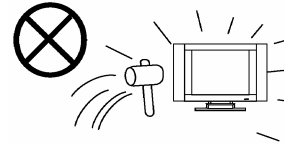

**23. Pixel defect**---The LCD panel is a very high technology product, giving you finely detailed pictures. Occasionally, a few non-active pixels may appear on the screen as a fixed point of blue, green or red. Please note that this does not affect the performance of your product.

## Using the Remote Control

● Use the remote control by pointing it towards the remote sensor window of the set. Objects between the remote control and sensor window may prevent proper operation. Cautions regarding use of remote control

**Note:** the illustration is for your reference only, the remote sensor may locate differently with different model.

### Cautions regarding use of remote control

- Do not expose the remote control to shock. In addition, do not expose the remote control to liquids, and do not place in an area with high humidity.
- Do not install or place the remote control under direct sunlight. The heat may cause deformation of the unit.
- The remote control may not work properly if the remote sensor window of the main unit is under direct sunlight or strong lighting. In such a case, change the angle of the lighting or LCD TV set, or operate the remote control closer to the remote sensor window.

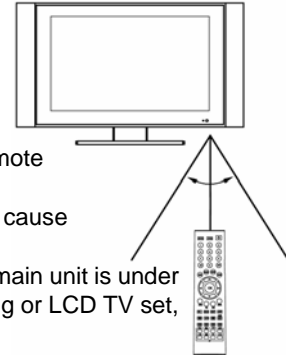

## Batteries for Remote Control

If the remote control fails to operate the LCDTV functions, replace the batteries in the remote control.

1 Open the battery cover.

2 Insert two size-AAA batteries.

3 Replace the cover and slide in reverse until the lock snaps.

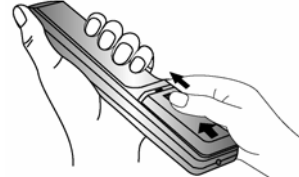
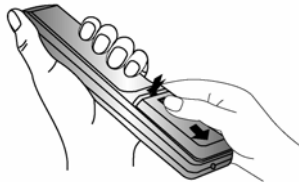

- Slide the cover while pressing down.
- Place the batteries with their terminals corresponding to the (+) and (-) indications in the battery compartment.

### Precaution on battery use

Improper use of batteries can result in a leakage of chemicals and/or explosion. Be sure to follow the instructions below.

- Place batteries with their terminals corresponding to the (+) and ( - ) indications.

- Different types of batteries have different characteristics. Do not mix batteries of different types.
- Do not mix old and new batteries. Mixing old and new batteries can shorten the life of new batteries and/or cause old batteries to leak chemicals.
- Remove batteries as soon as they are non-operable. Chemicals that leak from batteries can cause a rash. If chemical leakage is found, wipe with a cloth.
- The batteries supplied with the product may have a shorter life expectancy due to storage conditions. If the remote control is not used for an extended period of time, remove the batteries from the remote control.

## PACKING LIST

LCD TV	1
Operation Manual	1
Infrared Remote Control	1
3.5mm Audio Cable	1
AC Power Cable	1
AAA Batteries	2

### Note:

Please keep the wrapping box and the padding well for future convenient use when you convey them.

## GENERAL INFORMATION

- **Radio Frequency input; support CATV**  
Capable of receiving the full-append cable programs in 470MHZ
- **AV input**  
Capable of receiving PAL, NTSC, SECAM color systems; Very convenient to watch VCR (video cassette recorder), Pickup Camera, other Disc's programs
- **AV output**  
Capable of transmitting signal of different AV/RF systems to other AV receivers through the current AV cable
- **Y/C component signal input (same to S-Video input)**  
Convenient to receive the Y/C high definition component signal from DVD
- **YPbPr input**  
Capable of receiving the high definition YPbPr signal in 480i, 480p, 576i, 720p, 1080i, and 1080p formats
- **PC input**
  - a. Connecting with the host computer
  - b. Use as the display terminal
  - c. Connect the 3.5mm(diameter) audio cord to your computer's audio main board, you can listening the beautiful music transmitted from your host computer
- **DVI input** :Convenient to receive DVI signal
- **PIP, POP, PBP function**
- **Program & Child Lock**
- **Turn on with intelligence**

- **Zoom mode**
- **LTI, CTI, and black field**
- **BBE sound technology**
- **Trusurround sound technology**
- **Full-light display**
- **Picture amending display function**
- **Fleshtone enhancement and improvement**
- **Super definition display panel**
- **3:2, 2:2 Pull Down**
- **TV program scan function**
- **Timer function**  
Automatically off at certain preset time, and enters into the standby mode
- **Blue background with noise reduction**  
In TV, AV1, AV2 and YPbPr modes, screen displays soft blue background if there is no signal input
- **Auto Off if no signal input**  
In TV mode, the LCD TV will automatically power off within 15 minutes and enter into the Power Energy Saving Mode if there is no signal input.
- **Multi Language On-Screen Display menu**  
Ordinary and graphical user interface makes the menu operation more user-friendly
- **Plug and Play**  
No installation software is needed to use the TV as computer terminal display equipment
- **Auto adjustment in VGA mode**  
Adjust the picture's quality automatically
- **No flicker, no radiation, environment-protective and healthy**
- **Legerity, convenient, low power consumption**

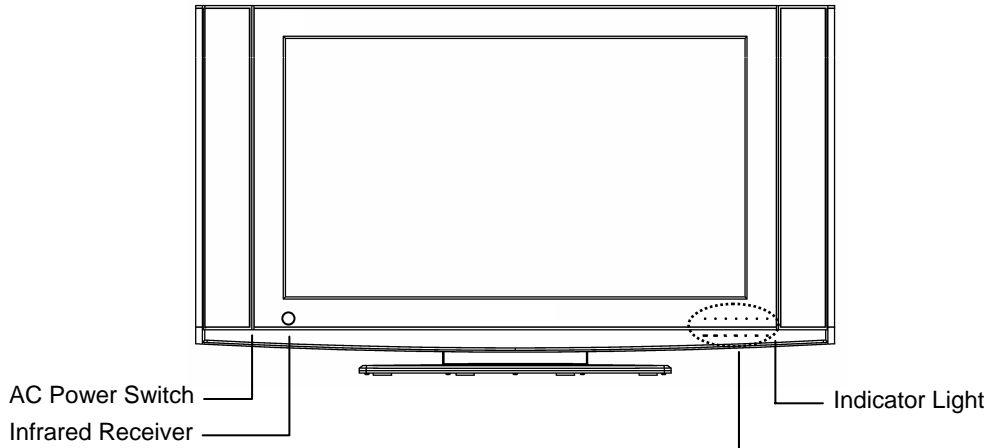

## BRIEF INTRODUCTION

### Front Panel

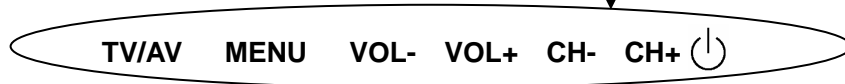

### Panel buttons



Button	Description
【TV/AV】	To scroll among TV, AV1, AV2, YPbPr, PC, and DVI modes. The same function to 【OK】 on R/C in menu operation.
【MENU】	To enter or exit from the OSD (On-Screen Display) menu. To browse the OSD menu.
【VOL-】	To decrease the sound volume. Adjust functions in menu operation.
【VOL+】	To increase the sound volume. Adjust functions in menu operation.
【CH-】	1. In TV mode, decrease channel number 2. To select functions in menu operation.
【CH+】	1. In TV mode, increase channel number 2. To select functions in menu operation.
【  】	To power on or put the LCD TV to STANDBY The same function to 【  】 on R/C .

### Note:

In this operation manual, 【】 symbol means Button.



Rear Panel

LT2618/LT3218

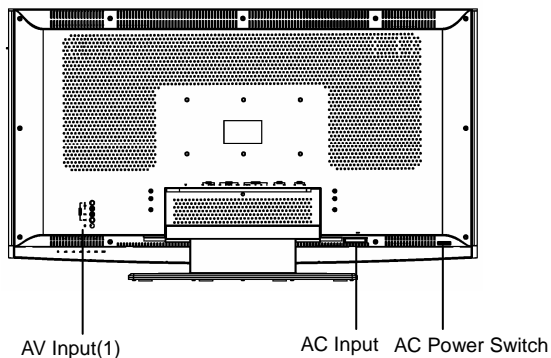

LT3718

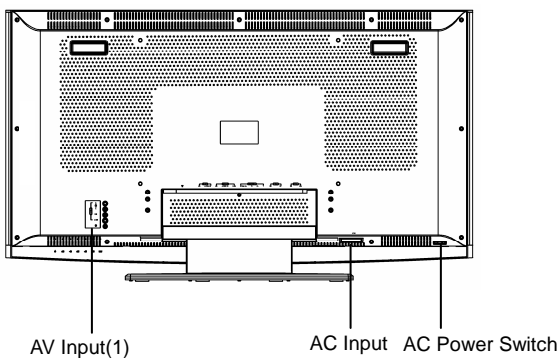

LT4018

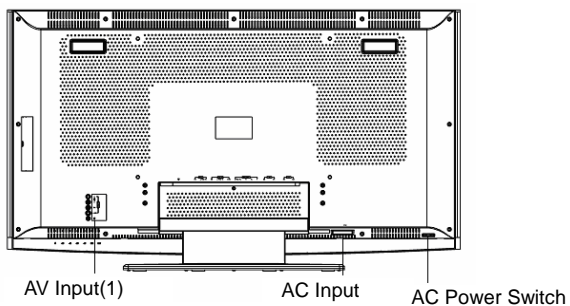

Items	Description
AC input	AC power input
AC power switch	To turn on/off the TV
Signal input/output terminals	AV input (1), headphone output, see illustration 1
Signal input/output terminals	TV signal input, AV output, AV input (2), YPbPr input, see illustration 2
Signal input/output terminals	Including PC and DVI input, see illustration 3

**Enlarged View of Signal Input/Output Terminals 1:**

LT2618/LT3218/LT3718

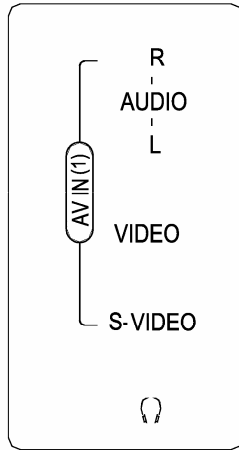

LT4018

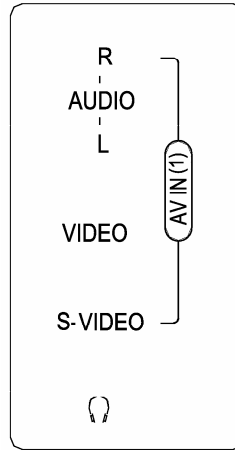

**Enlarged View of Signal Input/Output Terminals 2:**

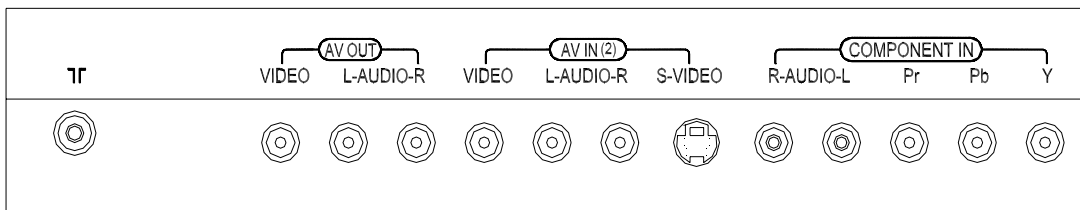

**Enlarged View of Signal Input/Output Terminals 3:**

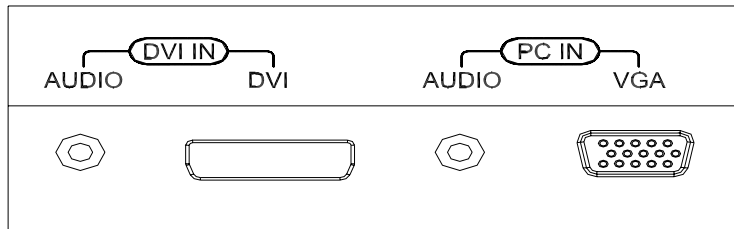

Items	Description
AV IN (1)	One-way AV input port; one-way S-Video input terminal; S-Video 1 is the first if VIDEO, S-Video 1 connect at one time, and the screen displays AV1 (Y/C)
HEADPHONE OUT	Headphone audio signal output
AV IN (2)	One-way AV input port; one-way S-Video input terminal; S-Video 2 is the first if VIDEO, S-Video 2 connect at one time, and the screen displays AV2 (Y/C)
AV OUT	For TV, AV1, and AV2 modes only
COMPONENT IN	Capable of transmitting YPbPr signal from DVD or other equipments to YPbPr input port
DVI IN	Digital video signal input
PC IN	PC signal input

# REMOTE CONTROL

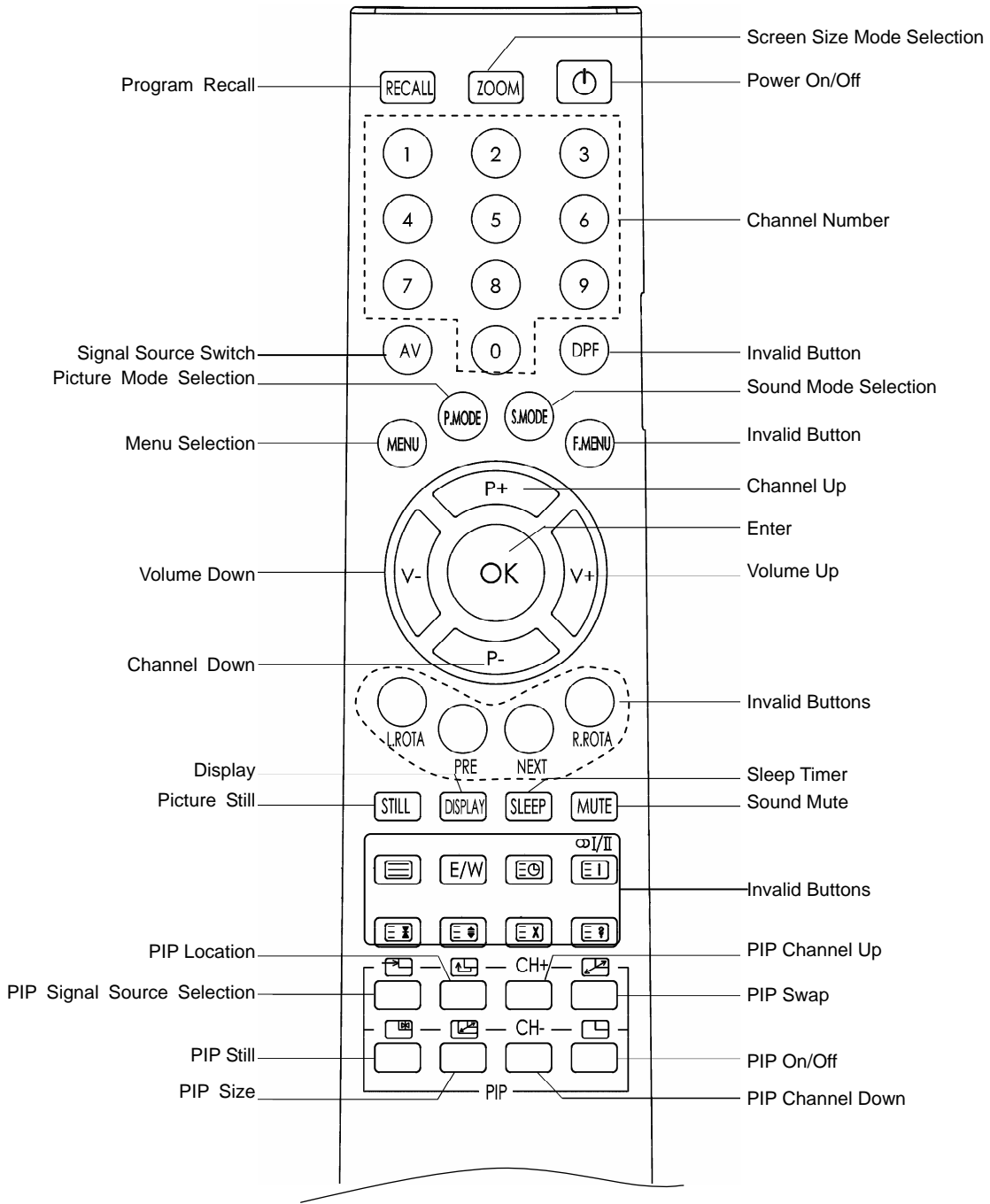

## TV Functions

- 1 . **RECALL** : Return to last viewed program or source
- 2 . **ZOOM** : Adjust displayable aspect ratio
- 3 . **POWER ON/OFF** : Switch on or off TV set
- 4 . **0-9 Channel Keys** : Key in the alphanumeric digits to switch to the designated channel directly
- 5 . **AV** : Toggle between different signal sources available
- 6 . **MENU** : To go to the On Screen Display(OSD) menus
- 7 . **P MODE** : Select different modes of picture settings
- 8 . **S MODE** : Select different modes of sound settings
- 9 . **P+** : Scroll to next channel
- 10 . **P-** : Scroll to previous channel
- 11 . **V-** :Decrease audio volume
- 12 . **V+** : Increase audio volume
- 13 . **OK** : Select or confirm sub menu of the OSD
- 14 . **DISPLAY** : Show info of current program
- 15 . **SLEEP** : Select time of TV to sleep mode
- 16 . **MUTE** : Mute sound
- 17 . **STILL** : Freeze or activate the image
- 18 . **PIP SOURCE SELECTION** : Select source of sub-picture source
- 19 . **LOCATION** : Adjust position of sub-picture frame
- 20 . **PIP CHANNEL UP** : Switch to the next channel of sub-picture
- 21 . **PIP SWAP** : Interchange main picture displayed with sub-picture source
- 22 . **PIP STILL** : Freeze or unfreeze screen sub-picture
- 23 . **PIP SIZE** : Adjust size or Mode of sub-picture
- 24 . **PIP CHANNEL DOWN** : Switch to the previous channel of sub-picture
- 25 . **PIP ON/OFF** : Turn on or off sub-picture function

### Note:

1. When in operation, please point your remote control directly to the infrared sensor.
2. Do not subject the remote control to impacts, water or disassembly.
3. When pressing the buttons on the remote control, allow interval of no less than one second between selections.

## INSTALLATION

1. Remove the LCD TV from the box and place it on a flat surface in a well-ventilated location.
2. Connect the output terminal of RF cable to the corresponding TV input terminal.
3. Connect AV signal output (DVD or other equipments) to AV input terminal of the LCD TV with AV connector. Ensure that every AV signal cable is connected correctly to the corresponding port.
4. Connect one side of PC, DVI terminals to the corresponding signal source terminal, and connect the other side to the corresponding LCD TV terminal. Screw down the thumbscrews on both sides to secure it. Affix the plug with care to avoid damage.
5. Connect the power cord to the AC outlet. Do ensure that other connected devices to the same power source are switched off.

### Caution:

Please refer the power range of this product to the back label on the back cover, do not connect to any power supply, which is out of this range. When unplugging the power cord, do not touch the metal part.

## GENERAL OPERATION

### To Turn the TV On

1. When you turn on the power, the indicator light on the front panel will blink till the TV displays pictures.
2. In Standby mode, press **【⏻】** on the remote control or front panel to enter to Power On mode.

### To Turn the TV Off

1. Press **【⏻】** on the remote control or **【⏻】** on the front panel to switch off the TV.
2. Unplug the power cord from the AC outlet to turn the TV off completely.

**Caution:** The TV will be shut off automatically when the power trips. The following will occur if the power cord is plugged the AC outlet then:

- a. The TV will be in standby mode when switched on
- b. The TV will be automatically on if it was in other modes (such as AV/PC mode) apart from TV mode

### Do not turn on/off the TV too often

### Auto Off if No Signal Input

The TV will automatically switch off and enter into Standby mode after 15 minutes if there is no signal, in cases of no program signal transmitted from the TV station or no commands from the remote control.

The AUTO OFF will be invalid after 15 minutes when there is no signal input.

### Indicator Light

Status	Light Color	Description
Working mode	Blue	The TV works normally
Standby	Red	In Standby Mode
Timer On	Blue	Timer On is valid. There is blue light when the TV is in Standby Mode
Power Off	No Indicator	The TV is turned off

## MENU OPERATION

1. Use the On Screen Display (OSD) menu to adjust the picture's quality.
2. Multiple languages to choose from.
3. The time range of the menu appearance is 3~60 seconds, which can be adjusted in the General Setting menu.
4. Use the Panel buttons or the Remote Control to operate the OSD MENU.

## FUNCTION INTRODUCTION

### Using the Channel Setting Menu (For TV Use Only)

- 1) Press **【MENU】** and then use **【V+】 / 【V-】** to select the Channel Setting menu in TV mode.
- 2) Use **【P+】 / 【P-】** to select the desired field.

#### Current Channel

Press **【V+】 / 【V-】** to increase/decrease the channel number.

#### Channel Label

Press **【OK】** to enter the edit mode.

Press **【P+】 / 【P-】** to select the desired letter, press **【V+】 / 【V-】** for next operation.

#### Color System

Switch among PAL, NTSC, SECAM, PAL M, PAL N, N4.43, and AUTO modes.

#### Sound System

Switch among B/G, I, D/K and M systems.

#### Skip

After Auto Search, there may be some vacant and pseudo programs received. Skipping the undesired program position can dramatically quicken program selection.

1. When one program is preset to Skip, you will find the program skipped during programs switch by pressing **【P+】 / 【P-】**.
2. Input the channel number directly to watch the program again that has been skipped.

#### Auto Search

In the Channel Setting Menu, press **【P+】 / 【P-】** to select Auto Search and press **【OK】 / 【V+】** to start Auto Searching mode.

1. During searching, the sound and color systems are automatically adjusted and programs are stored.
2. When search is finished, all 236 channels are stored, or **【MENU】** is pressed during the search process, the search will automatically stop and go to the channel setting

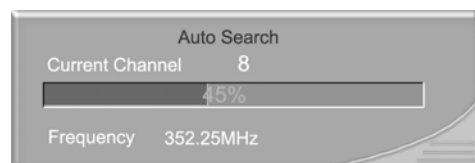
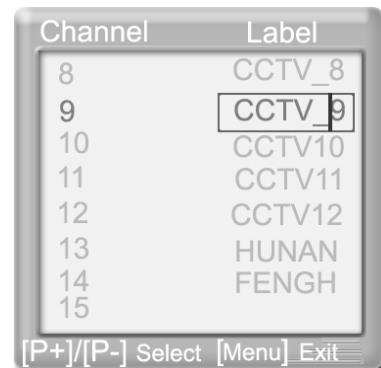

menu with channel one.

### Manual Search

In TV mode, select Manual Search option and press **【OK】** / **【V+】** to enter into Manual Search. Use **【V+】** / **【V-】** to search programs. After searching, the TV will automatically store searched channels and return to the menu.

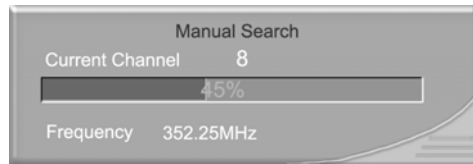

### Fine

When the picture and sound of a channel are not satisfactory after Auto Search or Manual Search, Fine function can be used to adjust the pictures and sound.

1. In TV mode, select Fine and press **【OK】** / **【V+】** to enter the Fine Tuning mode.

2. Press **【V+】** / **【V-】** to increase or decrease the frequency value for fine-tuning.

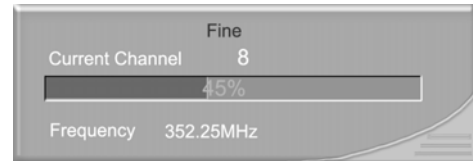

### **Note:**

During auto search, manual search, and fine tune operation, a password needs to be entered if any program is locked.

### Channel Table

Two kinds of program list Air & Cable to be chosen, 2~69 for Air list, and 1~125 for Cable list.

**Note:** This function is for U.S.A users only.

### Auto Scan

In TV mode, select Auto Scan to activate the scan mode. All pictures will be displayed in the current channel. The current program will be displayed in the middle of the screen, with twelve small pictures around the middle picture. All pictures are scanned, beginning with the current program, from the upper-left side screen in clockwise direction. Use **【P+】** / **【P-】** and **【V+】** / **【V-】** to select the desired channel; Use **【OK】** to exit from the Auto Scan mode and watch only the selected channel. Use **【MENU】** to exit from the Auto Scan mode directly.

**Note:** There will be a stripe blank on the right side screen during Auto Scan, this situation is normal, for it is to better the viewing proportion.

### Exchange

In TV mode, select Exchange to enter the PBP mode.

Press **【V+】** / **【V-】** to switch between the main picture & sub-picture.

Press **【P+】** / **【P-】** or the number buttons to select between the channel 1 & channel 2.

Press **【OK】** to switch between the programs.



### **Using the Picture Setting Menu**

1) Press **【MENU】** and then use **【V+】** / **【V-】** to select the Picture Setting menu.

2) Press **【P+】** / **【P-】** to select the desired field.

Full light Watch

The TV adjusts the brightness of the LCD TV according to the environment.

Picture Mode

Four modes to be selected: Standard, Mild, Bright, User.

Brightness

To adjust the picture's brightness.

Contrast

To adjust the picture's contrast.

Saturation

To adjust the picture's saturation.

Sharpness

To adjust the picture's definition.

Hue

To adjust the picture's tint. (For NTSC signal only)

Color Temp

Four modes can be chosen: Warm, Normal, Cool, and User. (User mode is valid for PC & DVI only)

Fleshtone

To adjust the human skin tones

**Using the Audio Setting Menu**

- 1) Press **【MENU】** and then use **【V+】** / **【V-】** to select the Audio Setting menu.
- 2) Press **【P+】** / **【P-】** to select the desired field.

Sound Mode

To select the desired sound mode among Standard, News, Music and User

Bass

To adjust the accompanying sound's bass

Treble

To adjust the accompanying sound's treble

Surround

To select the surround mode among Off, Normal and Spatial

Balance

To adjust the balance between the left and right soundtracks



**MTS**

To select the desired mode of MTS (for U.S.A users only)

**BBE**

To turn BBE On or Off

**TruSurround**

To turn TruSurround On or Off

**Volume**

To increase or decrease the volume

**Using the General Setting Menu**

- 1) Press **【MENU】** and then use **【V+】 / 【V-】** to select the General Setting menu.
- 2) Press **【P+】 / 【P-】** to select the desired field.

**Language**

To choose the language options

**OSD H Position**

To adjust the OSD position horizontally

**OSD V Position**

To adjust the OSD position vertically

**OSD Timeout**

To adjust the length of time the OSD to be displayed on the screen without any commands

**Blue Screen**

To set the Blue Screen on/off when there is no signal input in TV, AV, AV1, AV2, YPbPr modes

**Close Caption**

Only valid for U.S.A users

**Scaler Mode**

To select viewable screen modes of Fill Screen, 4:3, Wide, Cinema and Sub Title.

**Factory Reset**

All users' settings can be reset to the default settings except the TV programs

**Transparency**

To adjust the OSD transparency

**Using the Timer Setting Menu**

- 1) Press **【MENU】** and then use **【V+】 / 【V-】** to select the Timer Setting menu.
- 2) Press **【P+】 / 【P-】** to select the desired field.



Sleep Time

To set the sleep time of the TV. This can be set with the remote control **【SLEEP】** button.

Current Time

Press **【OK】** / **【V+】** to enter the mode.

Press **【V+】** / **【V-】** to set the Minute/Hour and press **【P+】** / **【P-】** to adjust the time value.

On Time

Press **【V+】** / **【V-】** to set the Minute/Hour and press **【P+】** / **【P-】** to adjust the time value.

On Channel

To set the default channel when turning on the TV. Press **【V+】** / **【V-】** to change the channel number.

Off Time

Press **【V+】** / **【V-】** to set the Minute/Hour and press **【P+】** / **【P-】** to adjust the time value.

Timer Mode

To set the clock time mode.

**Using the Child Lock Setting Menu**

- 1) Press **【MENU】** and then use **【V+】** / **【V-】** to select the Child Lock Setting menu.
- 2) Press **【P+】** / **【P-】** to select the desired field.

In this mode, press **【OK】** / **【P-】** to enter the password mode. Press the number button to enter the password. The default password is 1601.

After entering "1601" for the first time, the screen displays the menu on the right.

Press the number button on the remote control to set the new password. When done, press **【OK】**, and the TV will go back to the main child lock mode.

Press **【P+】** / **【P-】** to switch among Lock Status, Lock All and Clear All.

- ◆ In Lock Status mode, press **【OK】** / **【V+】** to enter the set mode. Then press **【P+】** / **【P-】** to select the channel and press **【V+】** / **【V-】** to set lock/unlock.
- ◆ A prompt appears when a locked channel is switched. The password needs to be entered to watch the program.
- ◆ In Lock All mode, press **【OK】** / **【V+】** to lock all of the programs.

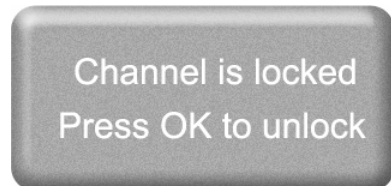
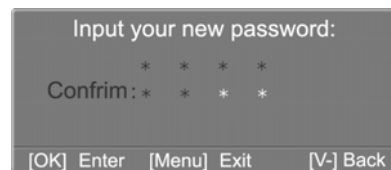

Channel	Label	Lock/Unlock
6	CCTV_6	Lock
7	CCTV_7	Lock
8	CCTV_8	Lock
9	CCTV_9	Unlock
10	CCTV10	Unlock
11		Lock
12		Lock
13		Lock

[P+]/[P-] Select [V-]/[V+]Change [Menu] Exit

- ◆ In Clear All mode, press **【OK】** / **【V+】** to unlock all of the programs.

**Note:** In child lock menu operation, each function cannot be activated until the correct password is entered. If the password is forgotten, the default password of "1601" is still valid.

#### Using the PC Setting menu (for PC mode only)

- 1) Press **【MENU】** and then use **【V+】** / **【V-】** to select the PC Setting menu.
- 2) Press **【P+】** / **【P-】** to select the desired field.

- Auto Tracking

To adjust automatically the picture's clock, phase, H Position and V Position to get the best visual effect

- Phase

To adjust pictures' sampling phase in PC mode

- Clock

To adjust pictures' sampling frequency .

- H Position

To adjust picture's position horizontally in PC mode.

- V Position

To adjust picture's position vertically in PC mode.

**Note:**

In the menu, gray items means invalid to operate in the current mode.



## OTHER FUNCTIONS INTRODUCTION

### Standby Mode

Press the **【Power】** on the TV panel/Remote Control, the LCD TV will store the current setup and enter into the standby mode with a red indicator light. To Power on the LCD TV, press the button again.

### Signal Switch

Press **【TV/AV】** on the remote control to select the signal sources orderly. They are TV, AV1, AV2, YPbPr, PC, and DVI.

The upper-right corner of the screen will display the corresponding information.

### Channel Selection

Press **【CH+】** / **【CH-】** on the panel or **【P+】** / **【P-】** on the remote control to increase/decrease the channel number. If a channel number is in SKIP ON mode, the next channel will display orderly.

Three numbers can be input at most, if you use the number button on the remote control.

The former two-digit input number is bigger than 23, the TV would come to the corresponding channel; If the input number is among 236 and 239, the current channel would not be replaced.

The program is the default setting if the range is 236~239.

In AV1, AV2, YPbPr, PC, and DVI modes, press the number buttons to watch the corresponding program.

**Note:** The biggest number you can input is 235 and use number buttons to input your desired channel number. During this input operation you can change to the corresponding channel directly with pressing **【OK】**, and press **【MENU】** to cancel.

### Volume Control





Press **【V+】** / **【V-】** to decrease or increase the volume continuously when the main menu is not displayed on the screen. The range is 0-100.

The Volume menu will automatically be off if there is no operation about 4 seconds.

### Mute

Press the **【MUTE】** on the remote control to turn On/Off the MUTE mode. Alternatively, press **【MUTE】**, change the volume level to turn the MUTE off.

The  Mute symbol will appear bottom-left corner of the screen the Mute function is switched on. Press **【MUTE】** or increase the value of volume, or adjust the items of the sound menu to exit.

The  Mute symbol is hidden when the menu operation is entered, but the feature is still valid. It appears again when the menu operation is exited. When there is no valid signal input, the TV will be mute (but no mute symbol) with a blue background.

### Sound Mode Selection

Press **【S.MODE】** repeatedly to select standard, News, Music, and User modes.

The value of Standard, News, Music modes are the default setting, and they cannot be adjusted. Only User mode can be altered.

### Picture Mode Selection

Press **【P.MODE】** to Switch among Standard, Mild, Bright and User modes

### Information Display

Press **【DISPLAY】** to reveal the current signal source and its corresponding information of Channel Number, Channel label, Color System, Stereo/FM Mono and signal source of PIP. Characters in green on the upper-right side display information for the main picture in TV mode while characters in red displays the source information for the sub-picture. Press again to exit.

2  
CCTV\_2  
PAL  
FM Mono  
PIP:PC

### Sleep Function

Press **【SLEEP】** to select the sleep time between intervals of 10, 20, 30, 60, 90, 120, 180 minutes or switch off the SLEEP function. A prompt will appear

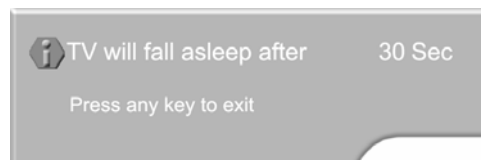

when it is one minute from SLEEP. Press any button to exit.

### Recall

In TV mode, press **【RECALL】** to view the previous channel or signal source.

In the other modes, press **【RECALL】** to return to the previous signal source

### Zoom Mode





Switch among Fill-screen, 4:3, Wide, Cinema and Subtitle modes.

### Still

Press **【STILL】** to freeze or activate the current image.

### PIP/POP/PBP Function

Press  to enter into or exit from the sub-picture mode. In this mode, you can realize these functions as follows:

1. Press  to switch the sub-picture signal source among TV, AV1, AV2, YPbPr, PC and DVI in cycle.
2. Press  to switch the sub-picture mode among PIP, PBP and POP.
  - Mode 1: To overlap a sub-picture (PIP) in small size wherever you want to locate;
  - Mode 2: To place two pictures in the same size side by side. Both main picture and sub-picture (PBP) cover half area of the display screen.
  - Mode 3: A main picture covers 12/16 area of the display screen while a sub-picture (POP) covers 1/16.
3. Press  to switch between main picture and sub-picture.
4. Press  to freeze or continue the current sub-picture.
5. Press  to adjust the sub-picture position on display in PIP mode.

Switches of the sub-picture's channel can be realized by pressing **【CH+】** / **【CH-】** in TV mode.

The sub-picture can enter into TV mode directly by pressing **【CH+】** / **【CH-】** in other modes.

Main Pic \ Sub Pic	TV	AV1	AV2	PC	DVI	YPbPr
TV	●	●	●	●	●	●
AV1	●	●	●	●	●	●
AV2	●	●	●	●	●	●
PC	●	●	●	●	●	
DVI	●	●	●	●	●	●
YPbPr	●	●	●		●	●

**Note:** All buttons mentioned in this operation are on the remote control, signs of “●” mean that both pictures can be displayed at the same time and the blanks mean that they can not be displayed at the same time.

## TROUBLESHOOTING

Before calling a technician, please check the following items to see if the below mentioned symptoms can be diagnosed and fixed.

Symptoms	Possible Reasons	Correction
No picture, no sound, and no indicator light on	1.The power cord is not plugged in 2.The power is off	1.Plug the power cord in 2.Turn the power on
No picture, no sound, but the green light indicator	1.Contrast, sharpness, color and volume are all in the minimum value or TV is in mute mode 2.PC has no signal in PC mode 3.The signal cord is not correctly connected	1.Alter the value of contrast, sharpness, color and volume 2.Press any button or input PC signal 3.Connect the signal cord correctly
Picture and sound with abnormality	1.Contrast, sharpness, and color are set improperly 2.Color system is set improperly 3.Sound system is set improperly	1.Adjust the value of Contrast, sharpness, and color 2.Set the Color system to the country broadcasting standard 3.Set the Sound system to the country broadcasting standard
Picture is spotted or with snow	Signal source is low-grade or the signal cord is in a lower quality	Use the qualified signal cord
Blue background in AV mode	No Video signal or the signal cord is improperly/not connected	Connect the signal cord properly
Picture is unclear, or moves or have black stripes on horizontal position in PC mode	Picture is not well adjusted	Adjust automatically by selecting Auto Adjust or adjust Clock、Phase、H Position、V Position manually after entering into the PC Setting menu to solve this problem
PC Picture is not in the middle of the screen		
No sound	No Audio signal or the signal cord is improperly/not connected	1.Connect the audio signal cord properly 2.Set the sound system properly
The remote control does not work	Batteries are improperly installed or exhausted	1.Make sure the positive and the negative polarities are correct. 2.Check if there is a loose contact between the batteries and the springs 3.Replace the batteries
Colors of PC Picture on display are improper	The user made the wrong Color Temp adjustment	Readjust the Color Temperature

## SPECIFICATIONS

Model: LT2618

Items	Specifications
Color System	PAL, NTSC, SECAM, PALM, PALN, N4.43
Sound System	D/K, I, B/G, M
PC, DVI Qualified Input Format	VGA/SVGA/XGA/WXGA 60Hz
YPbPr Input Format	480i, 480p, 576i, 576p, 720p, 1080i, 1080p
Audio Output Consumption	2x5w
AV Output	One way
Headphone Output	One way
AV (S-Video) Input	Two ways (audio is using in community)
YPbPr Input	One way
PC Input	One way
DVI Input	One way
Voltage Input	Please refer to the back label
Rated Power Consumption	
Standby Power Consumption	
Unit Dimension	874mm (W) × 512mm(H) × 225mm(D) (including the pedestal) 874mm (W) X488mm (H) X110mm (D) (Not Including the pedestal)
Recommended resolution in PC mode	1280x768 60Hz
Unit Weight	18.5kg(Approx.)

## SPECIFICATIONS

Model: LT3218

Items	Specifications
Color System	PAL, NTSC, SECAM, PALM, PALN, N4.43
Sound System	D/K, I, B/G, M
PC, DVI Qualified Input Format	VGA/SVGA/XGA/WXGA 60Hz
YPbPr Input Format	480i, 480p, 576i, 576p, 720p, 1080i, 1080p
Audio Output Consumption	2x5w
AV Output	One way
Headphone Output	One way
AV (S-Video) Input	Two ways (audio is using in community)
YPbPr Input	One way
PC Input	One way
DVI Input	One way
Voltage Input	Please refer to the back label
Rated Power Consumption	
Standby Power Consumption	
Unit Dimension	1012.6mm (W) × 586mm(H) × 225mm(D) (including the pedestal) 1012.6mm (W) X552.5mm (H) X112mm (D) (not including the pedestal)
Recommended resolution in PC mode	1280x768 60Hz
Unit Weight	21.5kg(Approx.)



## SPECIFICATIONS

Model: LT3718

Items	Specifications
Color System	PAL, NTSC, SECAM, PALM, PALN, N4.43
Sound System	D/K, I, B/G, M
PC, DVI Qualified Input Format	VGA/SVGA/XGA/WXGA 60Hz
YPbPr Input Format	480i, 480p, 576i, 576p, 720p, 1080i, 1080p
Audio Output Consumption	2x5w
AV Output	One way
Headphone Output	One way
AV (S-Video) Input	Two ways (audio is using in community)
YPbPr Input	One way
PC Input	One way
DVI Input	One way
Voltage Input	Please refer to the back label
Rated Power Consumption	
Standby Power Consumption	
Unit Dimension	1152mm (W) × 628.5mm(H) × 113mm(D) (not including the pedestal) 1152mm (W) X675mm (H) X272mm (D) (including the pedestal)
Recommended resolution in PC mode	1280x768 60Hz
Unit Weight	24.5kg(Approx.)

## SPECIFICATIONS

Model: LT4018

Items	Specifications
Color System	PAL, NTSC, SECAM, PALM, PALN, N4.43
Sound System	D/K, I, B/G, M
PC, DVI Qualified Input Format	VGA/SVGA/XGA/WXGA 60Hz
YPbPr Input Format	480i, 480p, 576i, 576p, 720p, 1080i, 1080p
Audio Output Consumption	2x5w
AV Output	One way
Headphone Output	One way
AV (S-Video) Input	Two ways (audio is using in community)
YPbPr Input	One way
PC Input	One way
DVI Input	One way
Voltage Input	Please refer to the back label
Rated Power Consumption	
Standby Power Consumption	≤2W
Unit Dimension	1236mm (W) × 717mm(H) × 274mm(D) (including the pedestal) 1236mm (W) X673mm (H) X106mm (D) (not including the pedestal)
Recommended resolution in PC mode	1280x768 60Hz
Unit Weight	27kg(Approx.)

*All the features and specifications are subject to change without notice for improvement.*

*LT2618/LT3218/LT3718/LT4018*

JUJ6.491.1168

